

# Technical datasheet

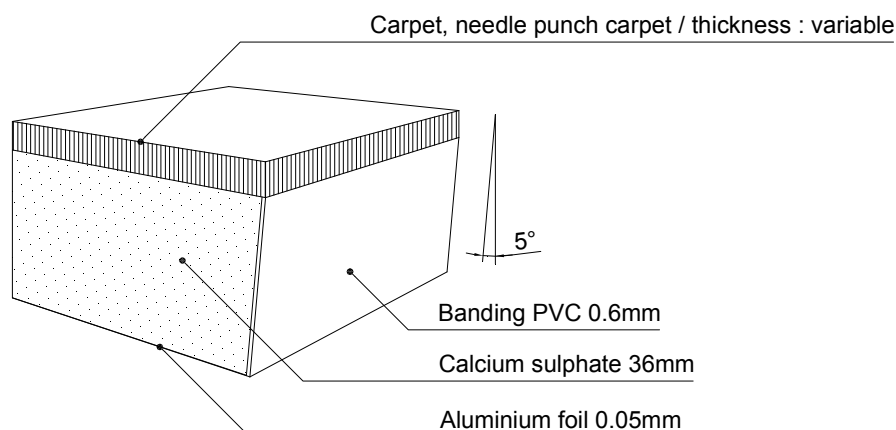

## 36 GAB-T

Tested according the European norm 12825

### General characteristics

Measurements	:	600 x 600 mm
Weight	:	+/- 19,5 kgs
Core	:	36 mm Calcium Sulphate Knauf - density 1500 kgs/m <sup>3</sup>
Bottom side	:	Aluminiumfoil 0,05 mm
Upper side	:	Covered with carpet or needle punch carpet
Edge banding	:	PVC 0,6 mm

### System characteristics

Class of element	:	2
Ultimate load	:	≥ 6 kN
Safety factor	:	2
Point load (= ultimate load/safety factor)	:	3 kN
Class of deflection (max 2,5mm deflection by 3Kn)	:	A
Divided load per m <sup>2</sup> (Theoretical value)	:	15kN–20kN / m <sup>2</sup>

### Fire characteristics

Fire resistance	:	F60 according DIN 4102-2
Fire reaction	:	Class A2 according DIN 4102-1

### Electrical resistance

10<sup>7</sup> - 10<sup>10</sup>Ω

Other values are possible by the use of conductive banding and conductive glue.

complete certificates on request

Jansen Products NV

Fabriekstraat 4  
3670 Meeuwen  
BELGIUM

Tel : +32 11 79 33 00  
Fax: +32 11 79 33 01  
info@jansenproducts.be  
www.groupjansen.com

 **jansen** PRODUCTS NV  
INTERNATIONAL